

CAMERA DIGITAL CAMERA C-120/D-380

OLYMPUS®

Quick start guide

We've included this convenient Quick start guide to show you basic functions and techniques that will help you quickly master your new camera. For more detailed descriptions of procedures, as well as for additional information on more sophisticated features not covered here, please refer to the printed "Basic Manual", or the primary "Reference Manual" on the CD-ROM.

Package contents

- Camera
- Strap
- AA (R6) alkaline batteries (4 pieces)
- USB cable
- Basic manual
- Quick start guide
- Software installation guide (included in the CD-ROM package)
- CD-ROM with Windows 98 USB driver software, Reference manual, and more.
- Warranty card/Registration card (not provided in some areas)
- Safety Precautions (booklet)
- SmartMedia
- Static-free case
- Index labels (2 pieces)
- Write-protect adhesive seals (4 pieces)
- SmartMedia instructions

OLYMPUS AMERICA INC.

Two Corporate Center Drive, Melville, NY 11747-3157, U.S.A. Tel. 631-844-5000
24/7 online automated help: <http://support.olympusamerica.com/>
Phone customer support: Tel. 1-888-553-4448 (Toll-free)

OLYMPUS OPTICAL CO. (EUROPA) GMBH.

Premises/Goods delivery: Wendenstraße 14-18, 20097 Hamburg, Germany
Tel. 040-237730
Letters: Postfach 10 49 08, 20034 Hamburg, Germany

OLYMPUS®
<http://www.olympus.com/>

Printed in Japan
1AG6P1P1295--

VT348201

1 Getting started

Attaching the strap

- 1** Thread the short end of the strap through the strap eyelet.
- 2** Thread the long end of the strap through the loop that has already gone through the eyelet.
- 3** Pull the strap tight, making sure that it is securely fastened and will not come loose.

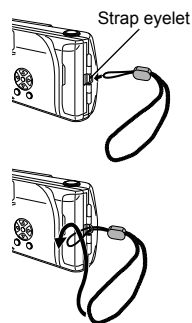

Loading the batteries

- 1** Make sure that:
The lens barrier is closed.
The monitor is off.
The green lamp is off.
- 2** Slide the battery compartment cover in the direction of **A** (the direction indicated by the **A** mark on the cover), and lift it up in the direction of **B**.
- 3** Insert the batteries, making sure that they are correctly oriented as shown in the illustration.

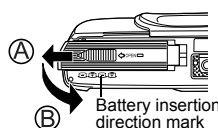
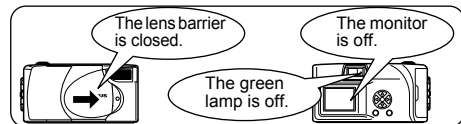

When using AA (R6) batteries

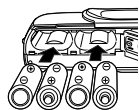

When using lithium battery packs

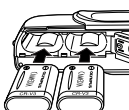

- 4** Close the battery compartment cover in the direction of **C**. While pressing the **D** mark, slide the cover in the direction of **D**.
If the battery compartment cover will not close easily, do not force it. Try pressing [OPEN] and the **D** mark with both hands.

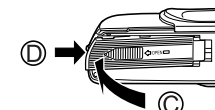

Inserting the card (SmartMedia)

- 1** Make sure that:
The lens barrier is closed.
The monitor is off.
The green lamp is off.
- 2** Open the card cover.
- 3** Insert the card as far as it will go in the direction shown in the illustration. There is an arrow inside the card cover, indicating the direction in which the card should be inserted.
- 4** Close the card cover securely until it clicks.
- Removing the card**
Hold the card with your fingertips and pull it out in the direction of the arrow.

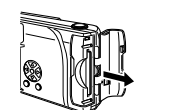
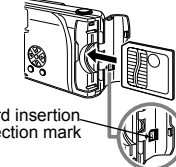
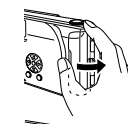
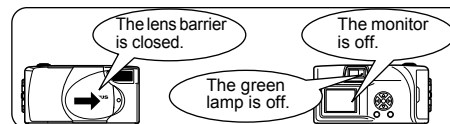

Caution Never open the card cover, or remove the card or the batteries while the camera is turned on. Doing so could destroy all data on the card. Destroyed data cannot be restored.

3 Shooting/Playback

Taking still pictures

- 1** Open the lens barrier.
Slide the lens barrier open until it clicks.
- 2** Position the target mark over the subject in the viewfinder.
- 3** Press the shutter button gently (halfway).
The green lamp on the right of the viewfinder lights up. The exposure is locked as long as the shutter button is kept pressed halfway.
- 4** Press the shutter button all the way (fully).
The camera takes the picture.

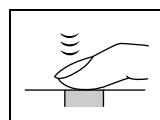
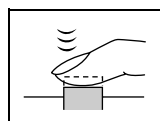
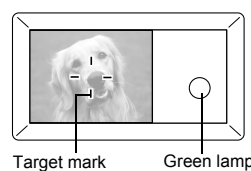

Playing back still pictures

- 1** Press **⏪** with the lens barrier closed.
The monitor turns on and displays the last picture taken.
- 2** Press **⏪**.
⏪: Displays the previous picture.
⏩: Displays the next picture.
- 3** Press **⏪** to cancel playback.
The monitor and camera turn off.

Recording movies

- 1** Press **⏪** with the lens barrier open.
The top menu in the shooting mode is displayed.
- 2** Press **⏪** to select DRIVE.
- 3** Press **⏪** to select **⏪**, then press **⏪**.
- 4** Record the movie while observing your subject on the monitor.
Press the shutter button fully to start recording. Press the shutter button fully again to stop recording.



Playing back movies

- 1** Press **⏪** with the lens barrier closed.
The monitor turns on.
- 2** Press **⏪** to display the desired picture with a **⏪** indicator, then press **⏪**.
The top menu is displayed.
- 3** Press **⏪** to select MOVIE PLAYBACK.
The movie is played back after the green lamp on the right of the viewfinder blinks and the movie data is downloaded to the camera. When the movie reaches the end, the display returns automatically to the beginning of the movie.
- 4** Press **⏪** to display the MOVIE PLAYBACK menu. Then select the desired operation and press **⏪**.
PLAYBACK: Plays back the entire movie again.
FRAME BY FRAME: Plays back the movie manually one frame at a time.
EXIT: Leaves the movie playback mode.



4 Erasing pictures

Single-frame erase

- 1** Press **⏪** with the lens barrier closed.
The monitor turns on.
- 2** Press **⏪** to select the picture you want to erase.
- 3** Press **⏪**.
The top menu is displayed.
- 4** Press **⏪** to select **ERASE**.
- 5** Press **⏪** to select YES, then press **⏪**.
The picture is erased and the menu is closed.



Caution Erasure is not possible if the picture you want to erase is protected or a write-protect seal is attached to the card. Before erasing, unprotect the picture or remove the write-protect seal from the card.
Once erased, pictures cannot be restored. Check each picture before erasing to avoid accidentally erasing pictures you want to keep.

2 Turning the power on/off

When shooting pictures

- Power on:**
Open the lens barrier.
The camera turns on in the shooting mode.
- Power off:**
Close the lens barrier.
The camera turns off.

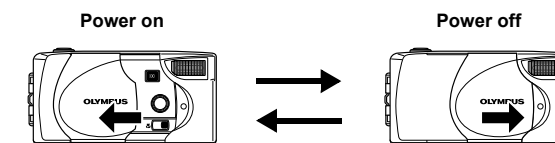

When playing back pictures on the camera

- Power on:**
Press the **⏪** (monitor) button with the lens barrier closed.
The camera turns on in the playback mode (the monitor turns on).
- Power off:**
Press the **⏪** (monitor) button.
The camera turns off (the monitor turns off).

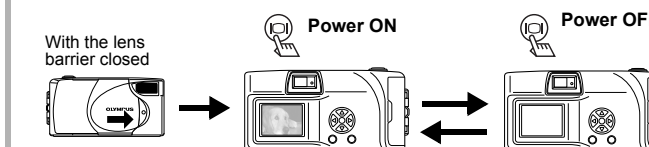

Note

- If you open the lens barrier without the card inside the camera, the NO CARD appears on the monitor. In this case, you can record pictures in the camera's internal memory.
- To save battery power, the camera automatically enters the sleep mode after about 3 minutes of non-operation. If the monitor is on, it will automatically turn off. The camera activates again as soon as you lightly press the shutter button or the **⏪** button. Whenever possible, turn the camera off when you do not intend to take any pictures for a while.

5 Protecting pictures

You are recommended to protect important pictures to avoid accidentally erasing them.

- 1** Press **⏪** with the lens barrier closed.
The monitor turns on.
- 2** Press **⏪** to select the picture you want to protect.
- 3** Press **⏪**, then press **⏪**.
The mode menu is displayed.
- 4** Press **⏪** to select the PLAY tab, then press **⏪**.
- 5** Press **⏪** to select ON, then press **⏪**.
- 6** Press **⏪** to select ON.
The selected picture is protected.
To close the menu, press **⏪** twice.

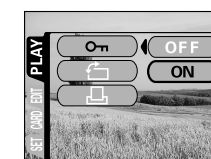
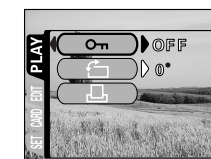

Note

- The **⏪** indicator is displayed at the top right of the protected picture.
- Protection on each picture remains even when the camera is turned off.

Caution

- Protected pictures cannot be erased by the single-frame/all-frame erase function, but they can be all erased with the format function.
- Protection cannot be applied to pictures stored on a card with a write-protect seal.

Names of parts

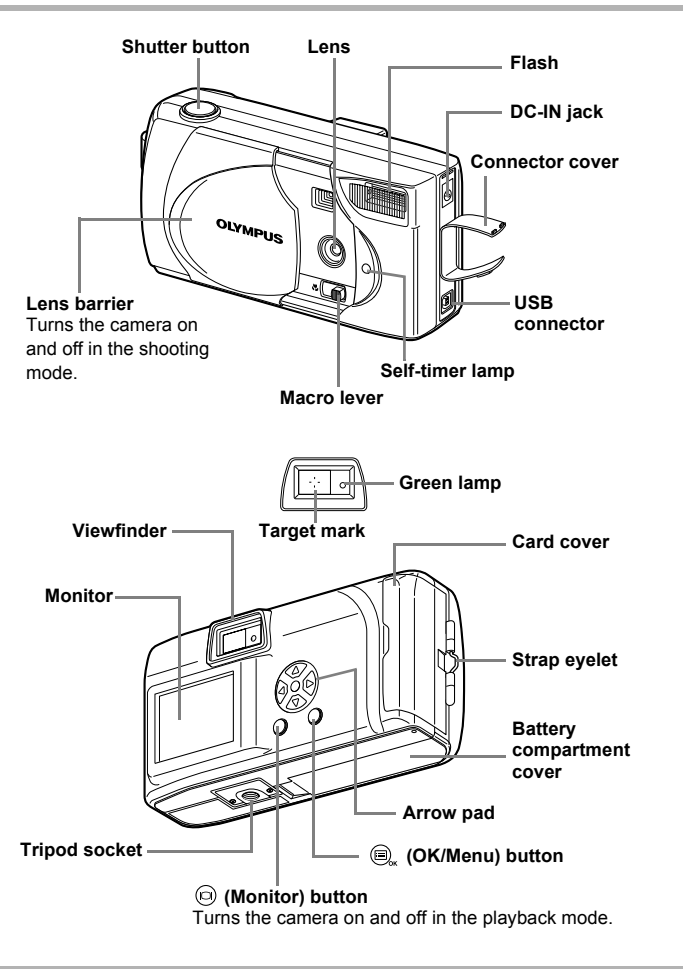

Using the menus and tabs

When you turn on the camera and press the (OK/Menu) button, the top menu is displayed on the monitor. The functions of this camera are set from the menus.

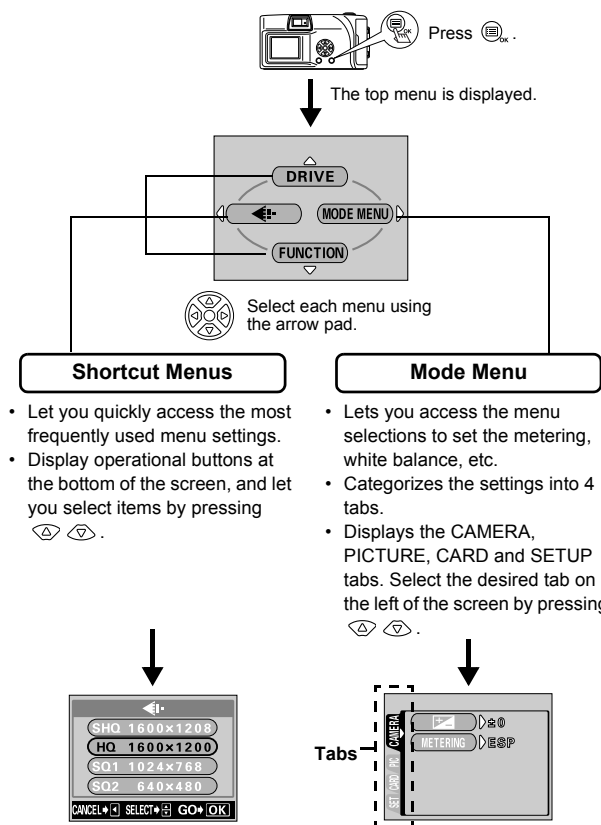

Shortcut menus

Shooting mode

When the still picture shooting mode is selected

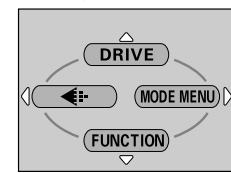

When the movie recording mode is selected

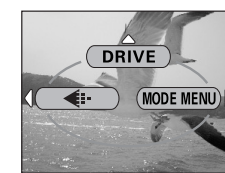

DRIVE

	Lets you shoot one frame at a time (normal shooting).
	Lets you shoot pictures in succession.
	Lets you shoot movies.

FUNCTION

	Lets you select the resolution and the quality of the image. Still picture : SHQ, HQ, SQ1, SQ2 Movie : HQ, SQ
--	---------------------------------------------------------------------------------------------------------------------

FUNCTION

2 IN 1	Lets you combine two still pictures taken in succession into one picture.
	Self-Portrait mode: Lets you take a picture of yourself while holding the camera.
PANORAMA	Allows panorama pictures to be taken with Olympus CAMEDIA-brand SmartMedia cards.

Playback mode

When a still picture is played back

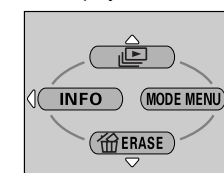

When a movie is played back

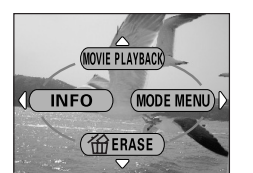

PLAYBACK

Displays all recorded pictures in slide-show fashion.

MOVIE PLAYBACK

Plays back a movie.

INFO

Displays all the shooting information on the monitor.

ERASE

Erases a selected picture.

How to use the menus

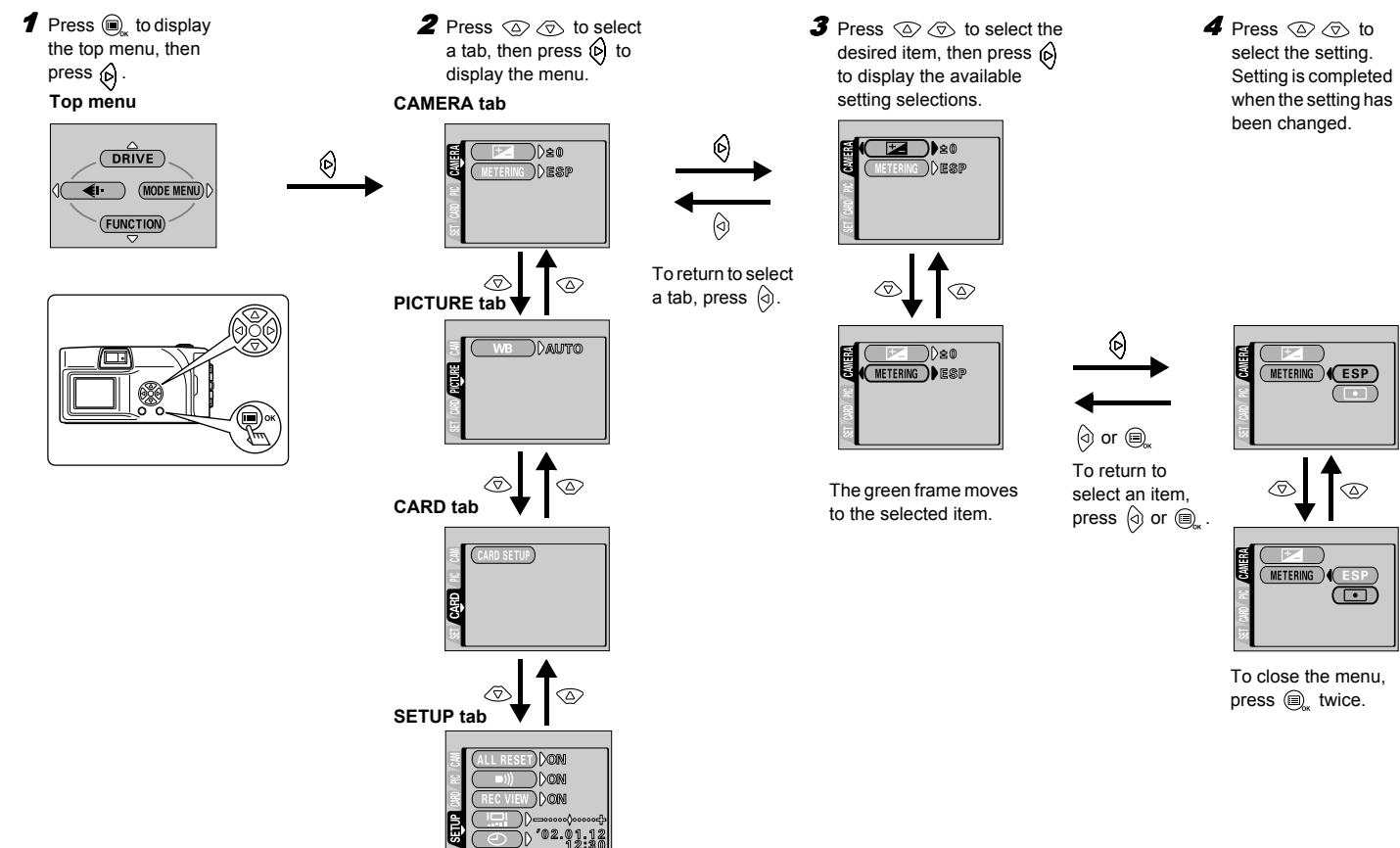

Mode menus

Mode menu functions are categorized into 4 tabs. Use (Left) (Right) to select a tab and display the respective functions.

Shooting mode

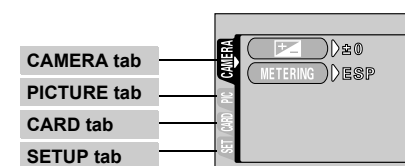

CAMERA tab		Adjusts the brightness of the image (Exposure compensation).
METERING		Selects the area of the image that will be used to determine exposure or image brightness from the two available settings: ESP or (Spot) (spot metering).
PICTURE tab	WB	Sets the appropriate white balance according to the light source.
CARD tab	CARD SETUP	Formats a card.
SETUP tab	ALL RESET	Selects whether to save the current camera settings when you turn off the power.
		Turns the beep sound (used for warnings, etc.) on and off.
	REC VIEW	Selects whether to display pictures on the monitor while saving them.
		Adjusts the brightness of the monitor.
		Sets the date and time.

Playback mode

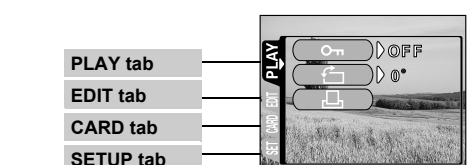

PLAY tab		Protects pictures from accidental erasure.
		Rotates pictures 90 degrees clockwise or counterclockwise.
		Stores printing information on the card required for DPOF printers.
EDIT tab	BLACK & WHITE	Creates black and white pictures.
	SEPIA	Creates sepia-toned pictures.
		Makes the file size smaller.
	INDEX	Creates an index picture of a movie in 9 frames.
CARD tab	CARD SETUP	Formats a card. Erases all image data stored on the card.
	BACKUP	Copies images stored in the internal memory to the card.
SETUP tab	ALL RESET	Selects whether to save the current camera settings when you turn off the power.
		Turns the beep sound (used for warnings, etc.) on and off.
		Selects the number of frames in the index display.
		Adjusts the brightness of the monitor.
		Sets the date and time.