

# Quick Start Guide FE-200

## Start Here

For more information, please refer to the Basic & Advanced Manuals or visit: [www.olympusamerica.com/support](http://www.olympusamerica.com/support)

OLYMPUS IMAGING AMERICA INC.

© 2006 OLYMPUS IMAGING CORP.  
Printed in China

VH745001

### 1 Gather these items (box contents)

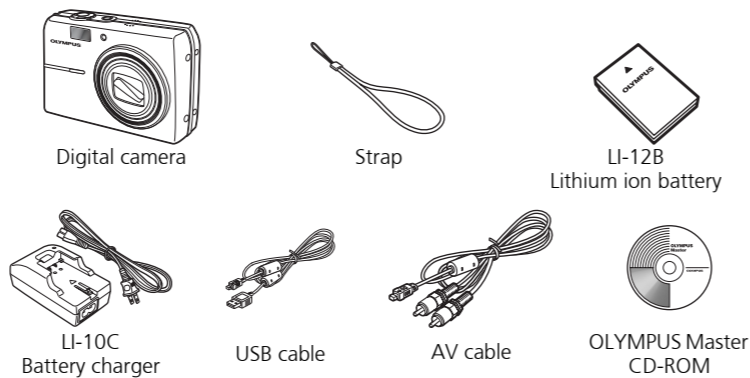

**Other items**

- Basic manual
- Advanced manual
- Warranty card

Contents may vary depending on purchase location.

#### Attach the strap

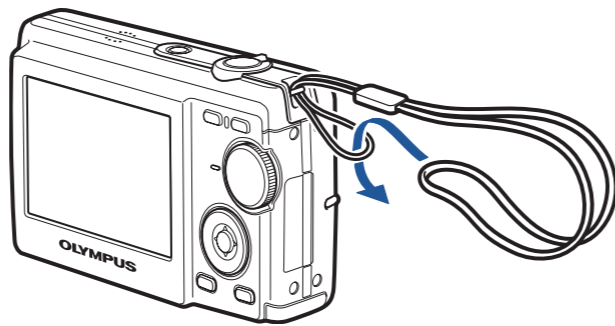

● Pull the strap tight so that it does not come loose.

### 2 Prepare the batteries

#### a. Charge the battery

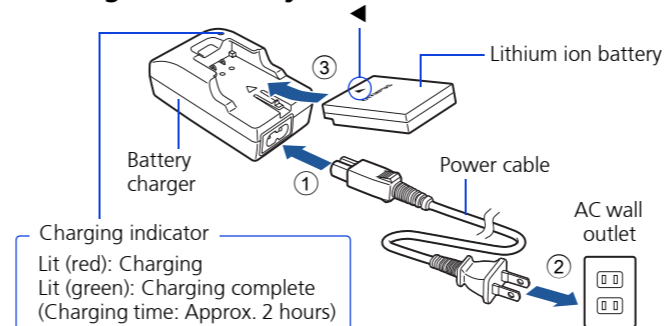

● Battery comes partially charged.

#### b. Insert the battery into the camera

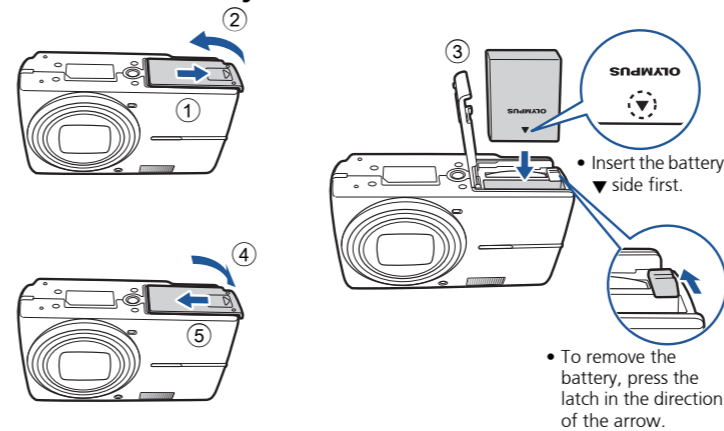

● For details on inserting an optional xD-Picture Card, please refer to Advanced Manual.

### 3 Turn on the power

This section explains how to turn on the camera in shooting mode.

#### a. Set the mode dial to **AUTO**

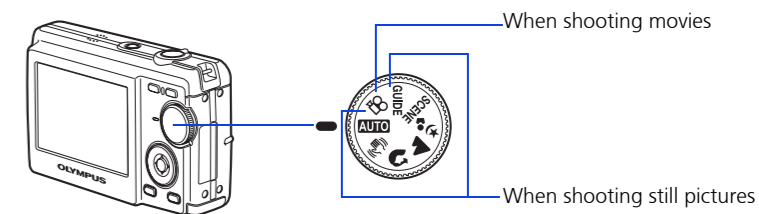

#### Still picture shooting modes

<b>AUTO</b>	The camera determines the optimum settings and shoots the picture.
	This function reduces the blur caused by a moving subject or camera movement when taking pictures.
	Suitable for taking pictures of people.
	Suitable for taking pictures of landscapes.
	Suitable for taking pictures of people at night.
<b>SCENE</b>	Shoot pictures by selecting a scene mode according to the situation.
<b>GUIDE</b>	You can set the items you want by doing the settings according to the shooting guide displayed on the screen.

#### b. Press the **POWER** button

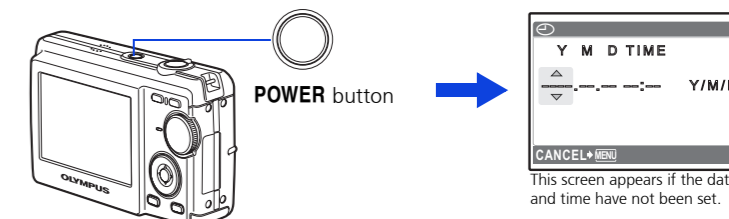

● To turn off the camera, press the **POWER** button again.

### 4 Set date and time

#### About the date and time setting screen

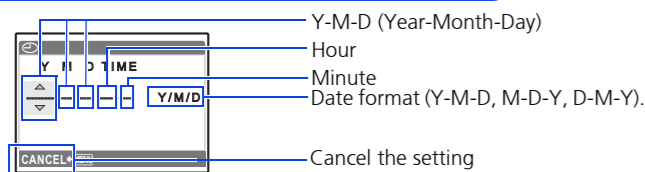

#### a. Press the $\Delta$ button and $\nabla$ button to select [Y].

● The first two digits of the year are fixed.

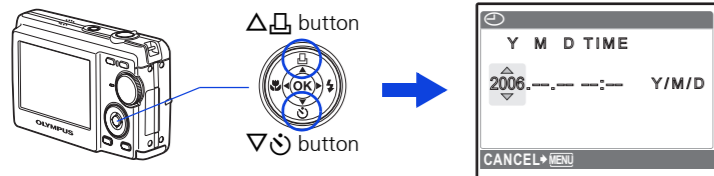

#### b. Press the $\triangleright$ button.

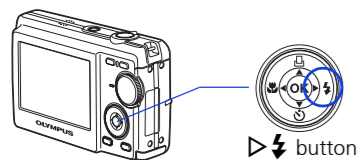

#### c. Press the $\Delta$ button and the $\nabla$ button to select [M].

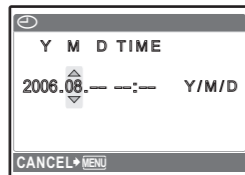

#### d. Press the $\triangleright$ button.

#### e. Press the $\Delta$ button and the $\nabla$ button to select [D].

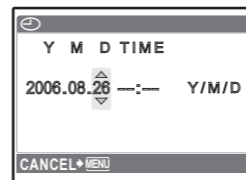

#### f. Press the $\triangleright$ button.

#### g. Press the $\Delta$ button and the $\nabla$ button to select "hour" and "minute".

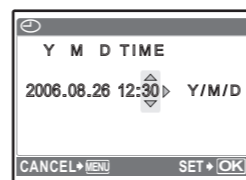

#### h. Press the $\triangleright$ button.

#### i. Press the $\Delta$ button and $\nabla$ button to select year, month and date.

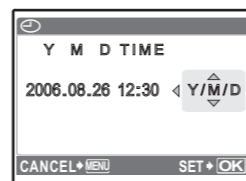

#### j. After all items have been set, press $\odot$ .

● The time is displayed in the 24-hour format.  
● For a more accurate setting, you can press  $\odot$  when the time signal hits 00 seconds.

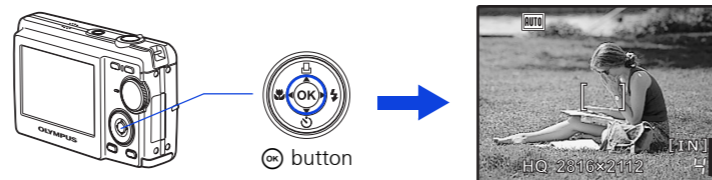

### 5 Shoot

#### a. Hold the camera



#### b. Focus

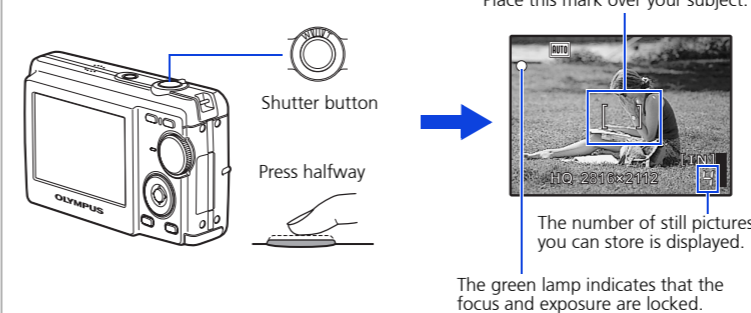

#### c. Shoot

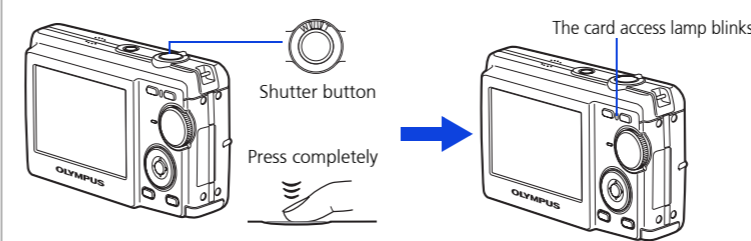

### 6 View pictures

#### a. Press the $\triangleright$ button.

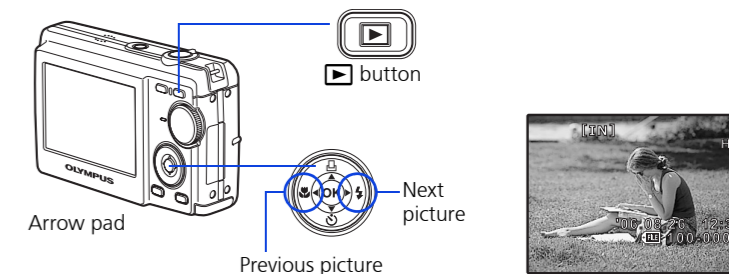

#### Erase pictures

#### a. As described in a. above, display the picture you want to erase

#### b. Press the $\text{trash}$ button.

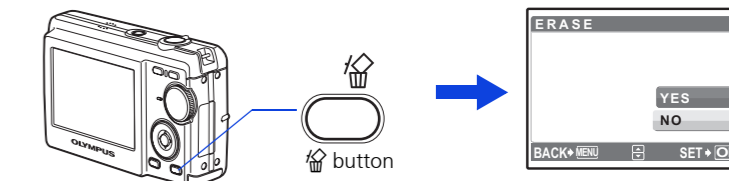

#### c. Press the $\Delta$ button to select [YES] and press $\odot$ .

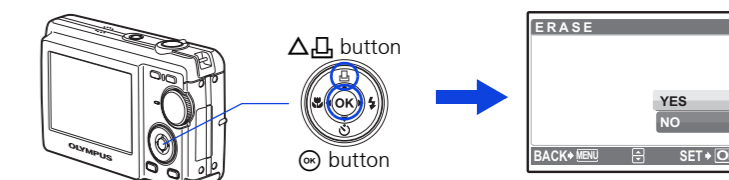

# Guia de iniciação rápida FE-200

## Começar aqui

Para maiores informações, consulte os Manuais Básico e Avançado ou visite a página web: [www.olympusamerica.com/support](http://www.olympusamerica.com/support)

OLYMPUS IMAGING AMERICA INC.

### 1 Reúna estes itens (conteúdo da caixa)

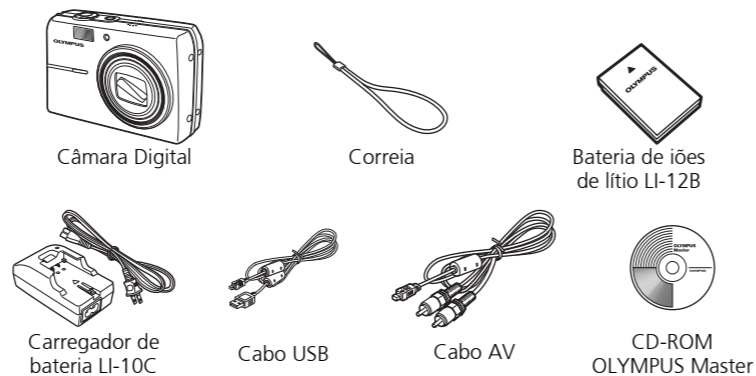

- Outros itens**
- Manual Básico
  - Manual Avançado
  - Cartão de garantia
  - O conteúdo pode variar conforme o local de aquisição.

### Colocar a correia

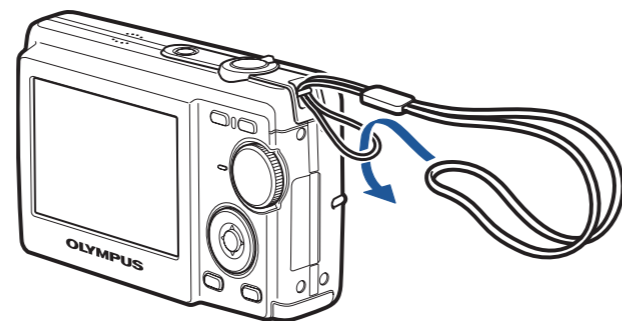

- Puxe bem a correia de modo que não fique frouxa.

### 2 Prepare a bateria

#### a. Carregue a bateria

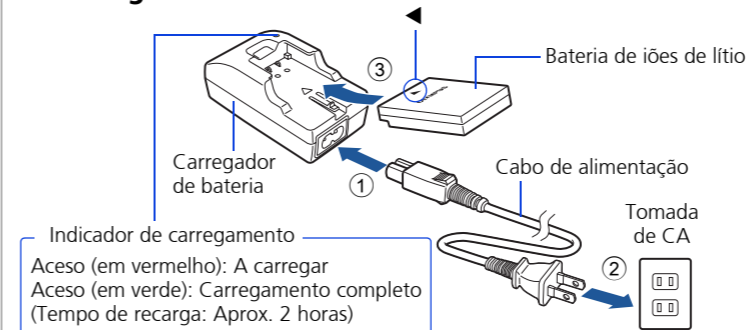

- A bateria vem parcialmente carregada.

#### b. Insira a bateria na câmara

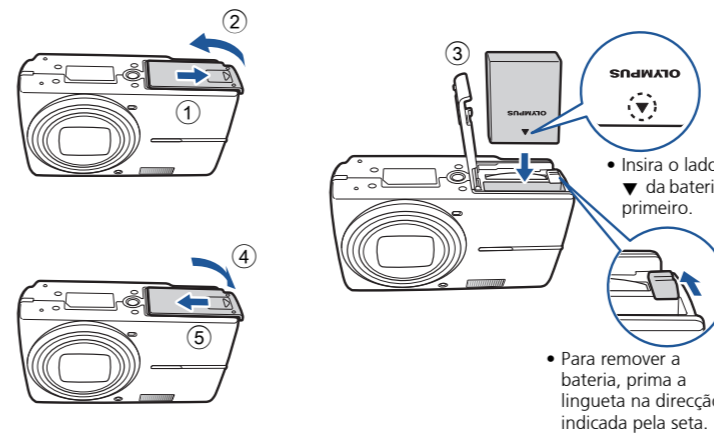

- Quanto aos detalhes sobre a inserção de um cartão xD-Picture Card, consulte o Manual Avançado.

### 3 Ligar a câmara

Esta secção explica como ligar a câmara no modo fotografia.

#### a. Ajuste o selector de modo para **AUTO**

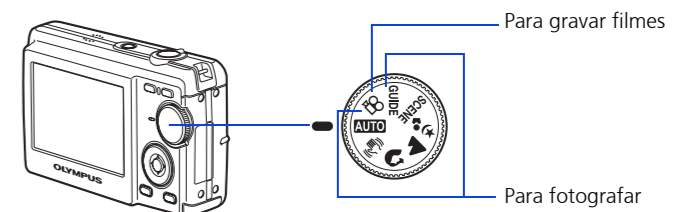

#### Modos de fotografia

<b>AUTO</b>	A câmara determina as definições óptimas e regista a imagem.
	Esta função reduz o efeito de arrastamento causado por um objecto móvel ou movimento da câmara quando fotografar imagens.
	Indicado para fotografar fotografias tipo retrato.
	Indicado para fotografar paisagens.
	Indicado para fotografar pessoas à noite.
<b>SCENE</b>	Selecione um modo de cena para registar imagens de acordo com a situação.
<b>GUIDE</b>	É possível definir os itens desejados, mediante a definição dos parâmetros de acordo com o guia de fotografia exibido no ecrã.

#### b. Prima o botão **POWER**

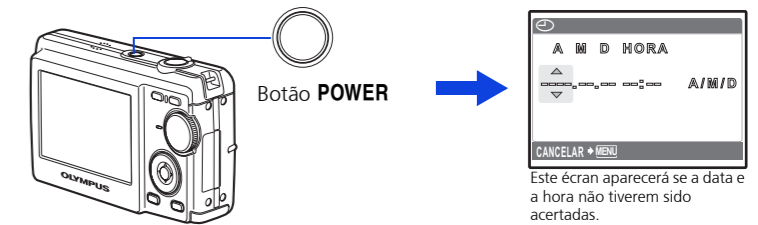

- Para desligar a câmara, prima o botão **POWER** novamente.

### 4 Acertar data e hora

#### Acerca do ecrã de acerto da data e da hora

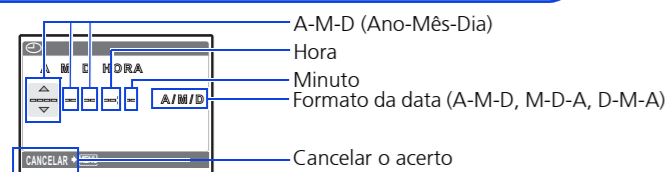

#### a. Prima o botão e o botão para seleccionar [A].

- Os primeiros dois dígitos do ano são fixados.

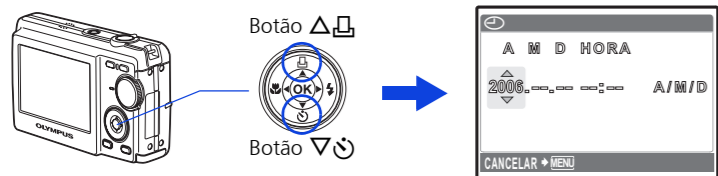

#### b. Prima o botão

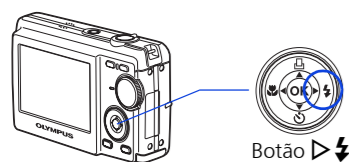

#### c. Prima o botão e o botão para seleccionar [M].



#### d. Prima o botão . e. Prima o botão e o botão para seleccionar [D].



#### f. Prima o botão . g. Prima o botão e o botão para seleccionar "hora" e "minuto".



#### h. Prima o botão . i. Prima o botão e o botão para seleccionar ano, mês e dia.



#### j. Após todos os parâmetros terem sido definidos, prima .

- A hora é exibida no formato de 24 horas.
- Para uma definição mais precisa, pode-se premir quando o sinal de hora chegar aos 00 segundos.

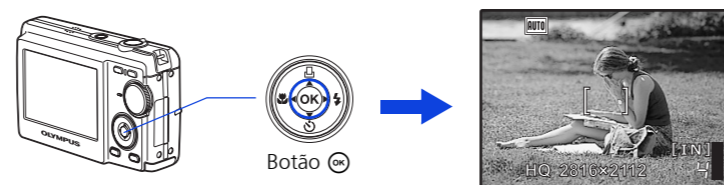

### 5 Fotografar

#### a. Segurar a câmara



#### b. Focar

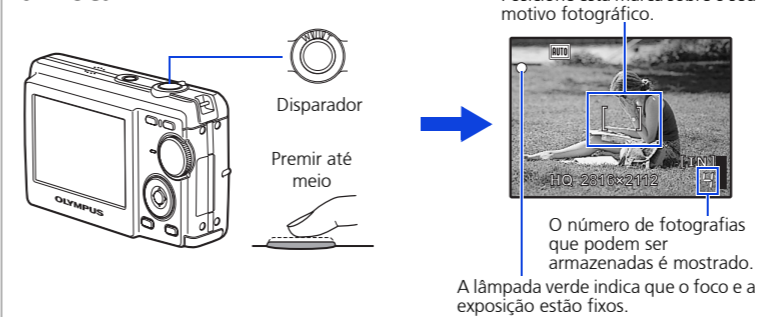

#### c. Fotografar

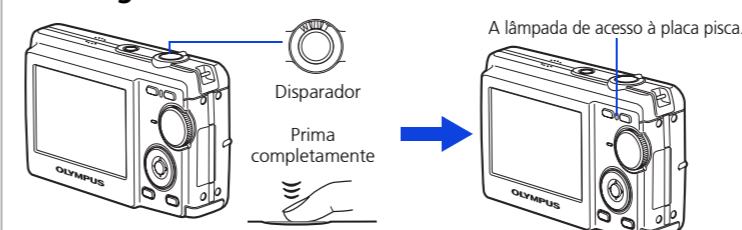

### 6 Ver as imagens

#### a. Prima o botão

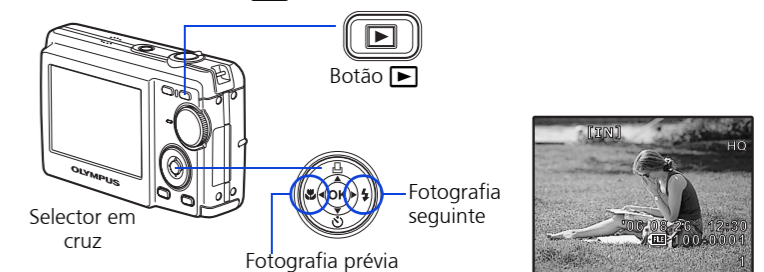

#### Apagar imagens

#### a. Conforme descrito acima, exiba a imagem que deseja apagar.

#### b. Prima o botão .

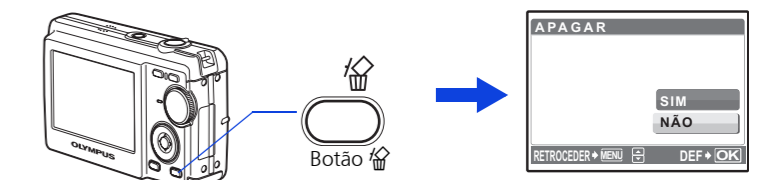

#### c. Prima o botão para seleccionar [SIM] e então prima .

